

An improved model of the dynamic behavior of a zero-to-landfill strategy for consumer products

JR Boyer

Plug Power Inc.

968 Albany Shaker Road

Latham, NY 12110 USA

jeff_boyer@plugpower.com

Abstract

Zero-to-Landfill is a corporate strategy that is gaining increasing attention throughout the world, driven by legal mandates and consumer demand. A product take-back process is required to ensure products that have reached the end of their useful lives are reclaimed for reuse, remanufacturing, or recycling. A dynamic model of the material flows that would exist within a take-back process was previously developed and presented. The results of dynamic simulations of a hypothesized product take-back strategy enabled identification of several corporate policies and opportunities that, if executed, could minimize the amount of material sent to landfills over the life cycle of a product. However, several extensions and modifications of that model were proposed to improve the results and behavior of the simulations. In this paper, an improved model of a reverse logistics system for a consumer product is presented, reflecting those changes. The new model agrees qualitatively with previous behaviors. Both versions showed comparable dynamic effects of closed-loop policies on material reclamation, product costs, and product adoption rate are investigated. The results of the latest simulations revealed unexpected and counter-intuitive effects between the collection and reclamation rates, product costs, product sales, and, ultimately, corporate revenues and profits. The results show that companies may have to strike a balance between profits, sales, material disposal, and product return rates.

Keywords: Sustainability, zero-to-landfill, strategy, remanufacturing, extended product responsibility.

Introduction

Sustainability is the ability "...to meet the needs of the present without compromising the ability of future generations to meet their own needs" (Brundtland 1987). Rapid growth in population and in standards of living around the world are causing corresponding increases in demand for limited and, in some cases, dwindling resources. Awareness of the adverse impacts of landfills is driving legal mandates to limit the amount and type of materials that may be thrown away. The need for sustainable business practices is rapidly growing in importance. Governments and forward-looking businesses are searching for ways to ensure availability of resources to meet growing demand.

While there are many ways for businesses to become sustainable, one means currently receiving

significant attention is the implementation of a zero-to-landfill (02L) policy in a business producing durable consumer goods. Returning obsolete or replaced products and service components for reuse, remanufacture, or recycling closes the loop on resource usage, thereby increasing the efficiency of material usage. The ability to meet a 02L goal and the effects of this strategy on sales and corporate earnings will develop over an extended period, making system dynamics an ideal tool to simulate the results of corporate actions. A recent review of the reverse supply chain and reverse logistics literature again found little system dynamics modeling within this area (see, for example, Debo 2003). However, several authors were found who acknowledged that their work reflects quasi-equilibrium conditions and that a time-dependent behavior exists in most cases.

In the previous report of this work (Boyer 2005), a dynamic model was presented that included the material stocks and flows associated with the reverse logistics of collecting and disassembling products, segregating and processing the components, and returning processed materials to production. It was shown that, to meet high levels of reclaimed and reclaimable materials, procurement of such components from other sources is required because production rates greatly exceed return rates, causing initial inventories of reclaimed components to be consumed rapidly. The earlier work demonstrated that throughput rates for returned goods have little influence on the amount that is not reclaimable, while cost and processing learning rates have significant impacts on reclaimable material in future product shipments. It was also shown that a true 02L goal is difficult to achieve in the absence of waste-free processing, manufacturer control of the product at end of life, and availability of reclaimable components. Based on those findings, policies were suggested that could facilitate a successful 02L policy. Further, additions to the model were suggested to broaden its applicability and versatility and to make it more realistic.

In this paper, a modified and extended model of a 02L strategy is presented. Most significantly, product price and sales were related using the Bass diffusion model rather than a simple linear relationship. The financial calculations were then refined and broadened, although they generally were kept simple. Lastly, a means to vary product durability as a function of time within the product lifecycle was included to account for “infant mortality” failure rates of new products.

Material stocks and flows

In this work, products continue to be defined as “machines,” since the specific products being considering are durable goods such as automobiles and appliances, rather than consumer products such as toasters and furniture. While material quantities could be described in units of mass or volume or number of parts, the unit “machine” was chosen throughout. All stocks and flows therefore represent an equivalent number of machines, but, given sufficient details from bills of material or other data, these could be converted to mass, volume, or numbers of parts to more accurately represent real physical quantities. Fractions are used to indicate the relative amounts of complete machines that enter each of the flows in the model. These simplifications, however, do not affect the conclusions that may be drawn from the results presented here. Additionally, the model is generally applicable to any type of product.

The model of a product take-back system reflects the generic material flows shown in Figure 1.

In a closed loop, obsolete products and replaced parts are collected from the field, processed, and then returned to manufacturing inventory for use in another product. In reality, some additions to and losses from this loop are anticipated. The simple schematic in Figure 1 illustrates losses from the loop reflecting materials that cannot be reused or remanufactured. This includes disposal as well as materials sent for recycling. In the latter case, it is possible that some of this material is returned in the future in the form of purchased components. The schematic also includes material leakage due to materials not being returned to the product manufacturer.

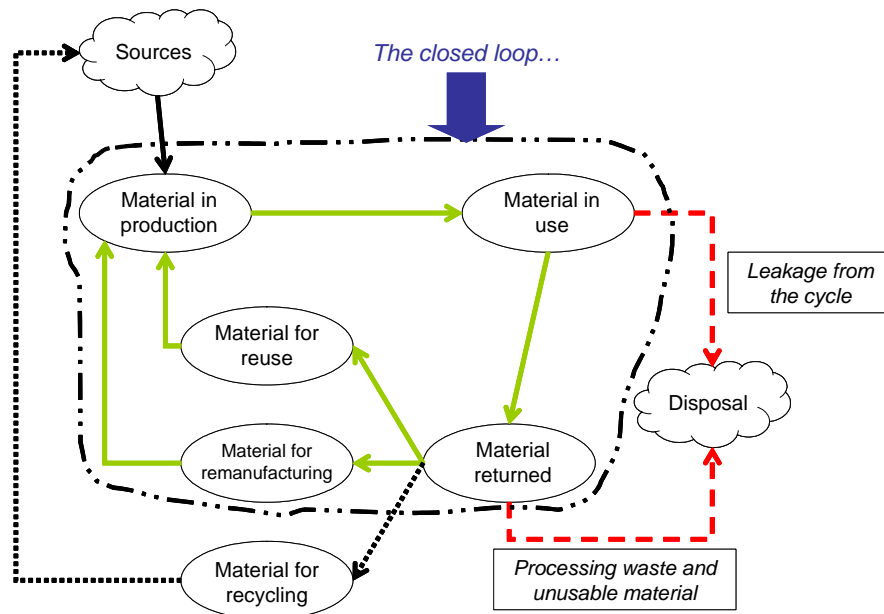

Fig. 1. A simplified product take back and remanufacturing system. The closed loop for material reuse is shown with input and losses.

Ideally, leakage would be zero in a closed loop logistics system; however, the emergence of third parties such as salvagers and a lack of financial incentives may cause purchasers to divert service parts and obsolete equipment away from the original equipment manufacturer (OEM). One solution is to lease durable products. The OEM retains ownership and can therefore create a higher probability of collecting the product when no longer needed by the lessee.

The stock-and-flow structure of the product take-back model is shown in Figure 2. There are four classes of materials and many steps in this system, as described below. Additional detail for the stocks and flows of remanufactured materials is shown in Figure 3. The complete model is provided as an Appendix.

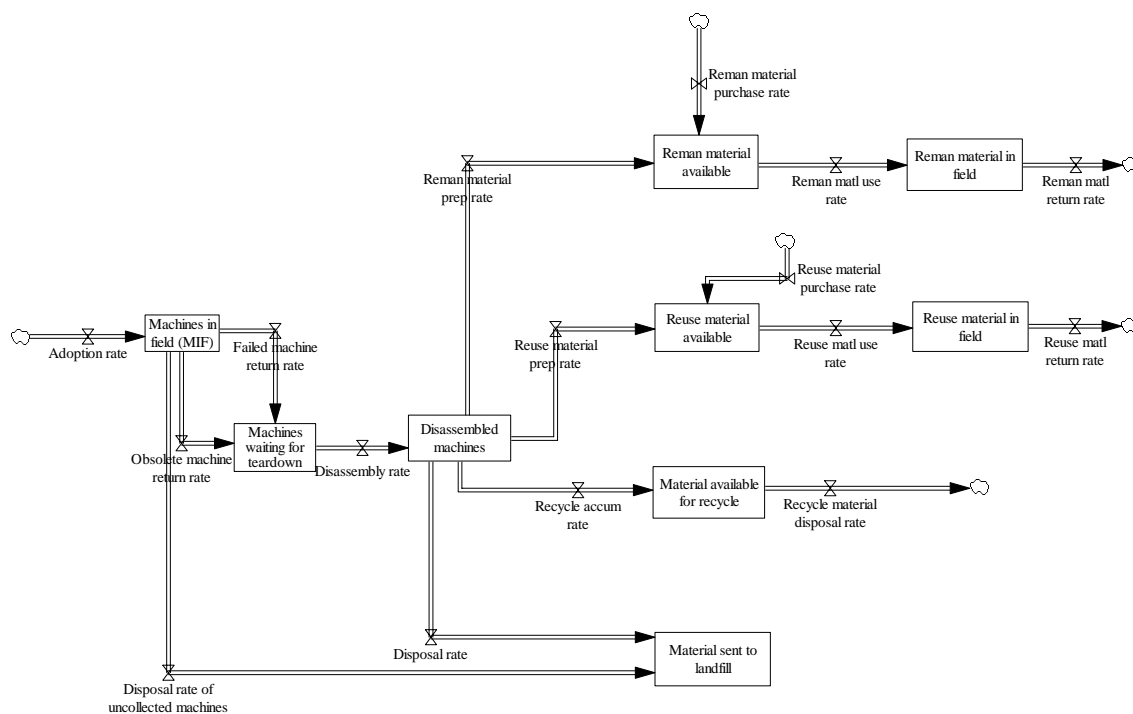

Fig. 2. Material stocks and flows in a simplified closed-loop system. Causal links and supporting variables removed for clarity. A more detailed portion of this section of the model is provided in Figure 3.

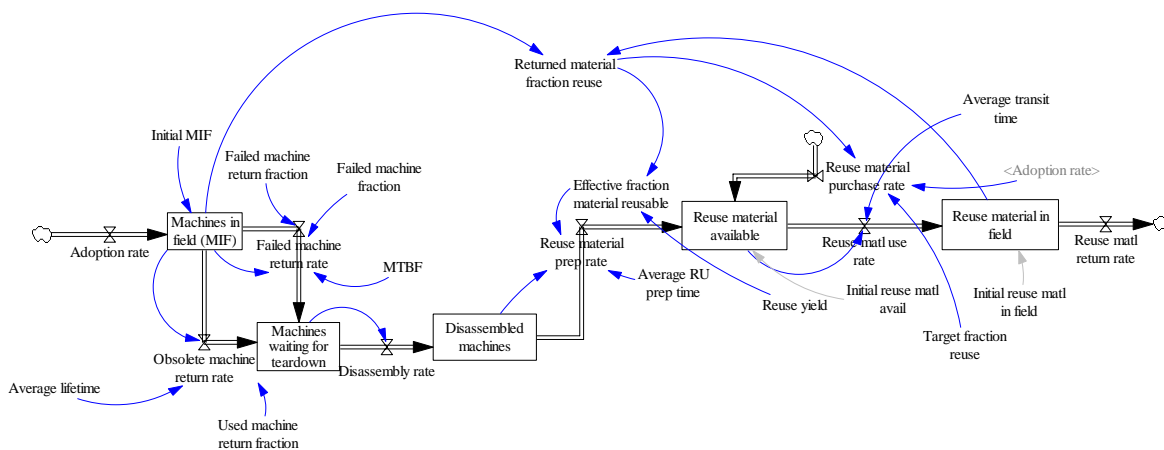

Fig. 3. Portion of model illustrating the causal loops and other details associated with material reuse. Some causal links have been removed for clarity; the full model is presented in the Appendix.

Installed machines may be removed from service due to obsolescence or due to failure. Components are replaced through preventive or corrective maintenance. Ideally, all of the machines that reach end of life and all replaced components will return to the manufacturer; however, some leakage from the loop is expected. Causes of such “lost” material may include a lack of sufficient incentive or obligation on the part of owners to return obsolete machines, emergence of an aftermarket of buyers and sellers, and greater difficulty and cost for service technicians to return replaced components than to dispose of them.

Once returned to the manufacturer (or perhaps a third-party service provider), machines are disassembled and the materials segregated for reclamation. The model has four parallel material flows, each of which is an aging chain. The four general types of materials are: (1) those that can be reused, (2) those that can be remanufactured, (3) those that can be recycled, and (4) those that are directly discarded. These divisions are based in part on those used by Chen, et al., in defining their cost benefit analysis (Chen 1993) and by Rogers and Tibben-Lembke in their review of reverse logistics trends and practices (Rogers 1998). The following definitions apply:

Reuse – a component is used again for the same purpose, requiring only simple processing such as washing to make it “like new.” Examples might be stainless steel pipes and fittings.

Remanufacturing – a component is returned to a “like new” state after some disassembly, cleaning, replacement of worn subcomponents, and reassembly. An example might be pumps returned to production after replacement of bearings.

Recycling – a component is reduced to its basic elements (Rogers 1998), which are then used in other products. An example might be rubber hoses and plastic components that are ground up and used as feedstock for new rubber or plastic products.

All other materials are considered unusable and destined for disposal in a landfill. In this paper, *reclaimed materials* include the reused and remanufactured components.

Several assumptions are made in the model regarding the segregation of returned materials. First, reuse and remanufacturing applies only to those components that may be used again in the manufacturer’s products; if not, they are part of the recycled or disposed quantities. Second, materials sent for recycling are not considered to be automatically returned to the manufacturer in the form of new components. Recycled materials represent a potential revenue stream resulting from the sale of materials that a manufacturer cannot use to processors or other entities.

Since materials that are not returned to the manufacturer are therefore not under the control of manufacturer, it is assumed that material leaking from the system will ultimately end up in a landfill. This may not be the case in actuality, but it is conservative and allows us to simulate the effects of such losses. Material is also assumed to be lost to landfills due to reuse material processing and remanufacturing; again, this provides another opportunity for control of the cycle to minimize waste.

Lastly, the model assumes the existence of reused or remanufactured components outside of the product returns. It also assumes that recycled content represents new materials that may be recycled and may include some recycled content themselves. This is similar to the packaging for many consumer products – the package as purchased contains some recycled material that (most likely) did not come from the package purchaser.

A new variable has been included in this model, the *Reclamation rate*. The *Reclamation rate* is the product of r , the *Reclamation fraction* representing the sum of the fraction of reused and the fraction of remanufactured components in machines being sold, and c , the *Collection fraction*, which is the fraction of material in the field that is returned to the OEM. For simplicity, equivalent values are used for *Failed machine return fraction* and *Obsolete machine return fraction*, which then are the same as the parameter c . (Different values could be used for each of the return fractions and c would then be some weighted function of the two, but the added complication is not expected to influence the conclusions.) Thus, rc represents the fraction of installed machines that is actually returned to production. This terminology is consistent with that presented by Geyer, et al. (Geyer 2005). The return fractions are assumed constant with time.

Additional details of the model are the same as previously presented (Boyer 2005).

Product Sales and Finances

The success of a product take-back program will rest substantially on the design of the product. Manufacturing methods, material choices, and design for disassembly are all required to facilitate component collection and processing in a timely and cost-effective manner. Existing products may not be optimized for such a strategy, while new ones can be. Thus, the model can represent the product life cycle from the point of product launch.

In the first iteration of this work, a linear relationship between product adoption rate and product price was used rather than a more realistic product diffusion model. This simplification allowed the model to be used to demonstrate trends in lieu of inclusion of a more robust model. The Bass diffusion model for product adoption (Bass 1969) has now been included along with modifications developed in Sterman (Sterman 2000). This is shown in Figure 4. Because obsolescence and failure are included as flows from the stock of installed machines, the model includes repeat sales through feedback from the number of installed machines (*Machines in Field*) to *Potential sales*. For simplicity, the condition of perfect substitution between new and reclaimed components is assumed so that market demand may be met regardless of the amount of reclaimed material in the product.

Separate cost functions for reused, recycled, and new materials are included (Figure 5), since the learning rates and costs are expected to differ for new and reclaimed components. The learning rate represents the fraction of cost reduction that occurs with each doubling of production due to operator learning, product and process improvements, and economies of scale (Teplitz 1991). A reverse logistics business model generated an estimate of an average 34% reduction in the cost of remanufactured and reused components relative to new ones (de la Puente 2005). For new material, the user may specify the cumulative number of equivalent new machines produced at which

the learning rate for new material changes. For the reclaimed materials, it is assumed that these experience curves hold for the entire period of the simulations. For each category of material, the cost for the first machine to be built of that material and a learning rate are specified.

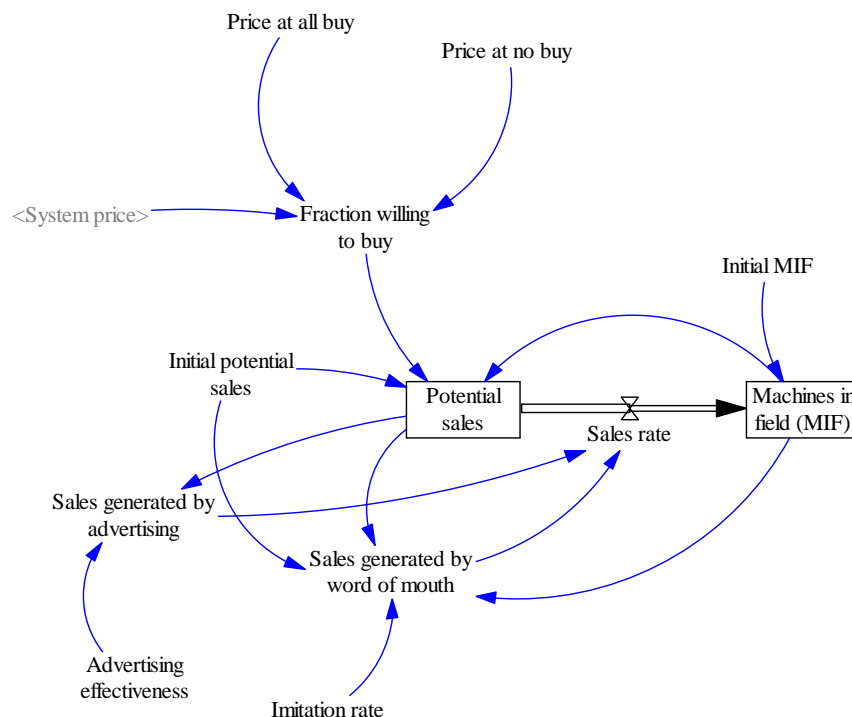

Fig. 4. Portion of the model illustrating the Bass diffusion model parameters. To account for purchase of machines to replace obsolete or failed machines, a feedback link is included from *Machines in field* to *Potential sales*.

Costs for reuse and remanufacturing are assumed to represent all costs associated with producing these materials – shipping of returned product, disassembly and segregation, processing, stocking, and any other associated costs. These represent the direct material costs for reclaimed components and materials. Additional descriptions of the parameters in the cost model are provided in (Boyer 2005). Total product cost is the sum of the costs for the reused, remanufactured, and new components. Product price is defined simply as cost plus gross margin.

When new products are introduced, a common pricing strategy is to sell them at a price that does not include a company's entire typical gross margin. As costs decrease, the company may choose to maintain a fixed price, enabling it to capture more of its indirect costs. The model described herein incorporates a variable gross margin. The gross margin is assumed constant whenever the resulting price is less than the maximum price the market will bear (*Price at no buy*). For all other conditions, the gross margin decreases linearly to zero to ensure that the product price does not exceed *Price at no buy*.

An additional enhancement of the model is the calculation of gross profit achieved by the prod-

uct. Gross profit is calculated as the sum of gross margin from product sales plus revenues from sales of recyclable material, less disposal costs incurred by the OEM (Figure 6).

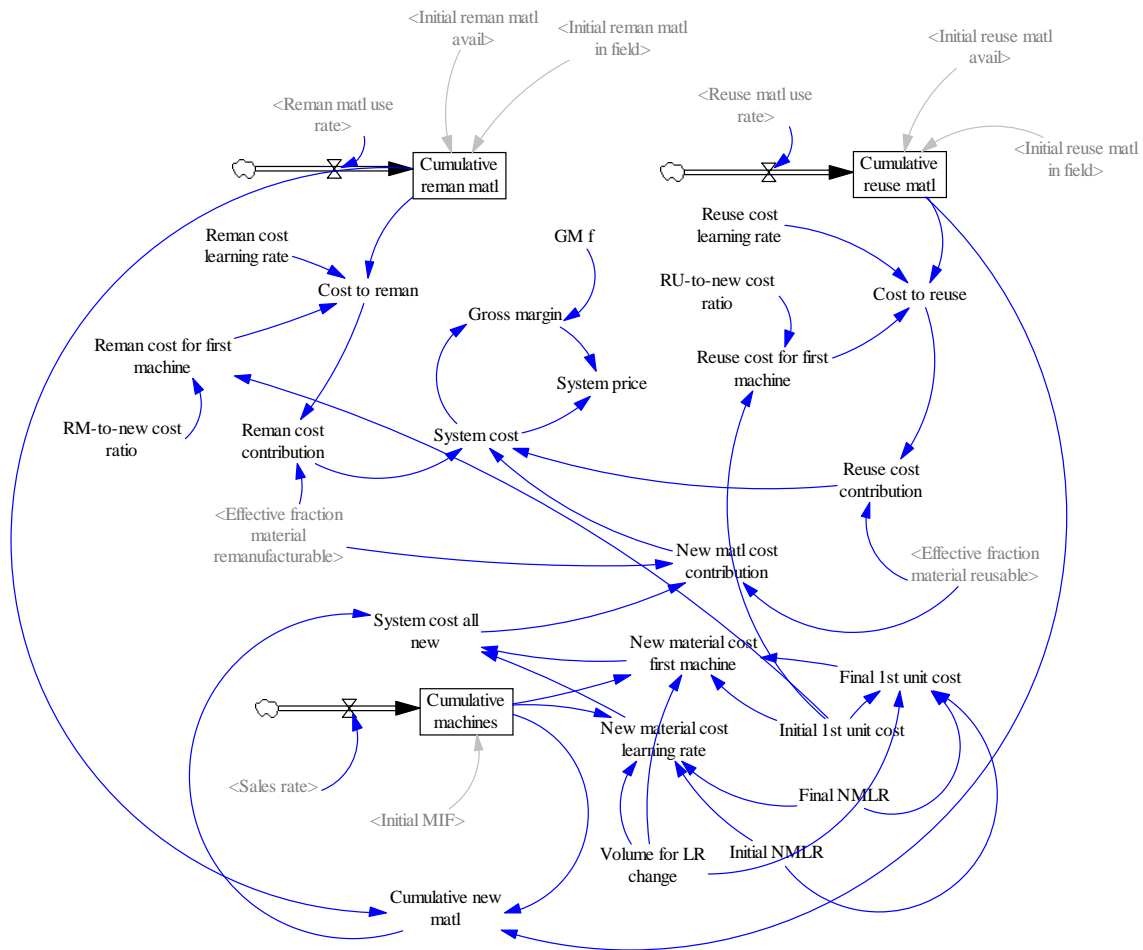

Fig. 5. Cost portion of the model. The variables in the lower right-hand corner of the causal loop diagram are used to establish the breakpoint in the learning rate for new material (*Initial NMLR* and *Final NMLR*).

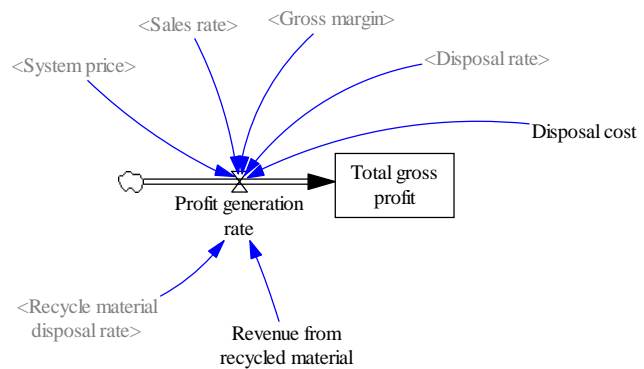

Fig. 6. Gross profit accumulation portion of the model.

Effects of policies

The simulations examine the behavior of a zero-to-landfill strategy for a manufacturer of durable consumer products. Stationary fuel cell systems for distributed generation of power and heat were chosen as a representative product. A time horizon of 30 years was chosen for the product with a target nominal design life of 10 years. Again recognizing that there will be a reliability learning curve, a time-dependent mean product lifetime is included. Specifically, it is assumed that the product reaches an *Average lifetime* of 10 years five years after product launch (time 0). It is further assumed that future product revisions will incorporate substantial backward compatibility with installed components and will maintain the condition of perfect substitution. The values of the key input parameters for this company are provided in Table 1. These are generic values extracted from information in the public domain, and are not representative of any particular company or product (see Boyer 2004 and Boyer 2005 for details and sources).

Comparison with Previous Results

The first simulations performed examined the dynamic behavior of the simulated reverse logistics system. A comparison of the behavior under the same set of conditions (see Table 1) using the previous, highly simplified adoption model and using the new model is shown in Figure 7. One exception was made. The learning rate for new material in the new model was reduced from 15% to 5% when the cumulative number of equivalent machines reached 50,000 units.

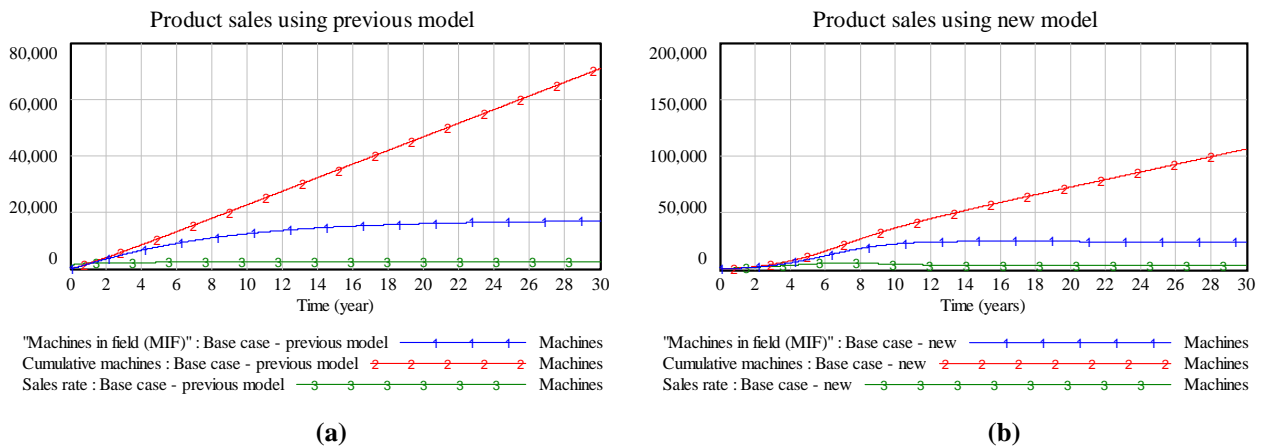

Fig. 7. Market behavior for the same product using (a) the model reported previously and (b) the model reported herein.

The system behavior using the Bass model reflects the classical patterns in Figure 7b, including a limit-to-growth for the number of machines installed in the field. The previous model resulted in a parabolic growth curve. The total sales are reduced by a factor of two from the previous model to the new one. Lastly, the number of installations reaches equilibrium after 14 years with the new model compared with approximately 24 years with the previous model.

Table 1. Summary of the values of key input parameters for the simulations. A complete listing of the model is provided in the Appendix. Other constants are similar to those reported in (Boyer 2005).			
Parameter	Value	Units	Comments
Advertising effectiveness	0.03576	1/year	Derived from product adoption projections; see (Boyer 2004).
Average lifetime	10	Years	Increasing from 0 at time = 0 to 10 years at time = 5 years. Constant after time = 5 years.
Average RU prep time	0.25	Years	
Average reman time	0.25	Years	
Disposal cost	75	\$/machine	Assumes a weight of 1 ton per equivalent machine and a typical disposal cost of \$75/ton (based on reviews of several published landfill rates for commercial waste).
Failed machine fraction	0.02	Dimensionless	
Failed machine return fraction	0.8	Dimensionless	
Gross margin	0.5	Dimensionless	This is the maximum value. Increases from 0 to 50% as a function of machine cost to ensure the product price does not exceed the maximum market price.
Imitation rate	1.0114	1/year	Derived from product adoption projections; see (Boyer 2004).
MTBF	0.5	Years	
New material cost first machine	50,000	\$/machine	
New material cost learning rate	0.15	Dimensionless	Reflects a 15% reduction in cost with each doubling of production. (Dutton 1984)
Obsolete machine return fraction	0.8	Dimensionless	
Price all buy	0	\$/machine	Assumes the laggards are highly price conscious, or that other costs associated with the product (e.g., service and fuel) require a very low cost for economic justification.
Price no buy	60,000	\$/machine	Assumes a value proposition that maximizes acceptable cost.
Reman cost learning rate	0.05	Dimensionless	Reflects a 5% reduction in cost with each doubling of production. (Hess 2001)
Reman yield	0.9	Dimensionless	
Reuse cost learning rate	0.05	Dimensionless	Reflects a 5% reduction in cost with each doubling of production. (Hess 2001)
Reuse yield	0.9	Dimensionless	
Revenue from recycled materials	500	\$/machine	
RM-to-new cost ratio	0.66	Dimensionless	The expected ratio of the cost of a fully remanufactured product to the cost of a completely new product.
RU-to-new cost ratio	0.66	Dimensionless	The expected ratio of the cost of a fully reused product to the cost of a completely new product.
Target fraction reman	0.2	Dimensionless	
Target fraction reuse	0.8	Dimensionless	
Used machine return fraction	0.8	Dimensionless	

The equilibrium distribution of material content in shipped units is independent of the choice of model (Figure 8). The amounts of reclaimed, recycled, and disposed components are proportional to the number of machines in the field, and the rates of usage are proportional to the sales rate. Since *Machines in field* and *Sales rate* both differ between the model results in the same ratio, the fractionation will be the same. The new model, however, clearly indicates a multi-year period during which reductions in material sent to landfills is constant. This implies that a company should expect to make changes to eliminate this period of stasis if it wants to accelerate reductions in waste generation.

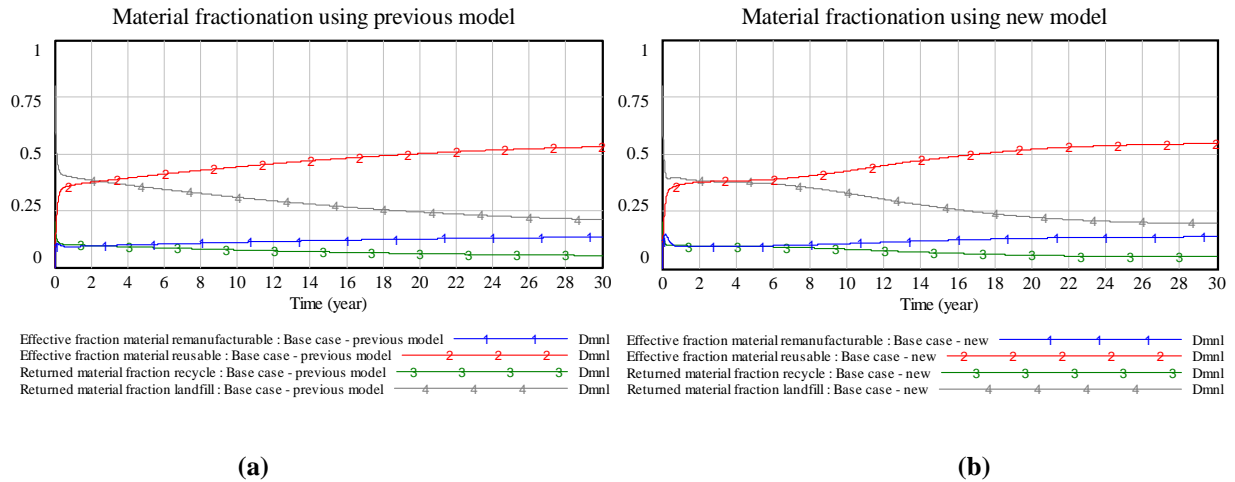

Fig. 8. Fractionation of materials in products using (a) the previously reported model and (b) the new model reported herein. In both cases, the target content for remanufactured components was 20% and the target content for reused components was 80%.

These results provide confidence that there is general agreement in behavior between the earlier model and the current model. Thus, conclusions drawn from the earlier results regarding trends and the impacts, if any, of certain corporate policies were appropriate. The diffusion model, although a more accurate means of forecasting the behavior of the market for this product, does not alter the overarching conclusions.

Effect of Learning Rates

The baseline model assumes a steeper learning curve for new parts than for reused and remanufactured parts. Reused and remanufactured parts will cost less at the beginning, but cost reductions will be slower with increasing volume because the preparation processes are commoditized (Hess 2001). Additionally, at some production level, the learning rate for new material will slow down. Figures 9, 10, and 11 illustrate the effects of increasing the learning rate for reclaimed material; all other parameters had the same values as in the baseline simulations discussed above. In all cases, the learning rate for new material was 15% for the first 50,000 equivalent new units produces and 5% thereafter. As expected, lower costs enable the manufacturer to charge lower prices, in turn increasing the rate of sales of the product.

Conversely, increased sales of lower-priced products generate less profit for the company as shown in Figure 12. And the resulting fraction of returned machines that is landfilled is unaffected (Figure 13). These results are counterintuitive. The expectation might be that an increase in sales rate will increase the number of installed machines, so that return rates increase along with throughput of reclaimed material, leading to higher fractions in “new” products. However, all of the material flows scale together, so the impact on material fractionation should not be affected. Striving for cost reductions alone is insufficient to decrease waste, while at the same time, this may adversely affect the corporate bottom line.

Fig. 9. Effect of the learning rate of reclaimed material costs on total system price. The learning rates for new material were the same in all three simulations.

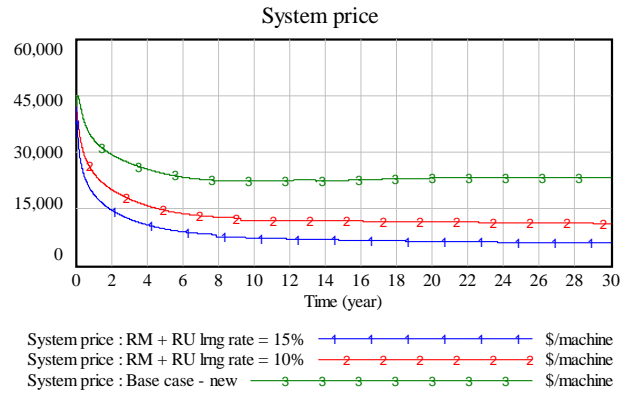

Fig. 10. Effect of the learning rate of reclaimed material costs on the sales rate for the product. The learning rates for new material were the same in all three simulations.

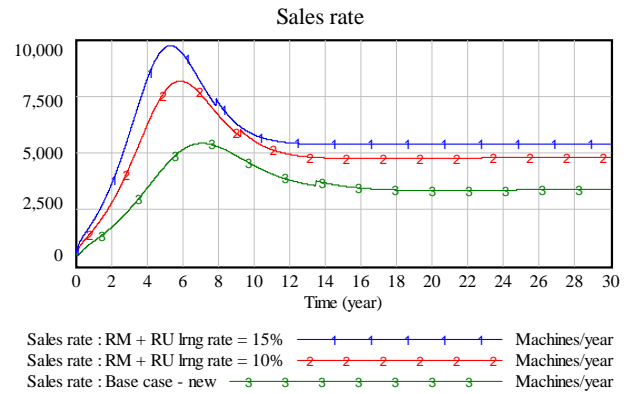

Fig. 11. Effect of the learning rate of reclaimed material costs on the number of installed machines. The learning rates for new material were the same in all three simulations.

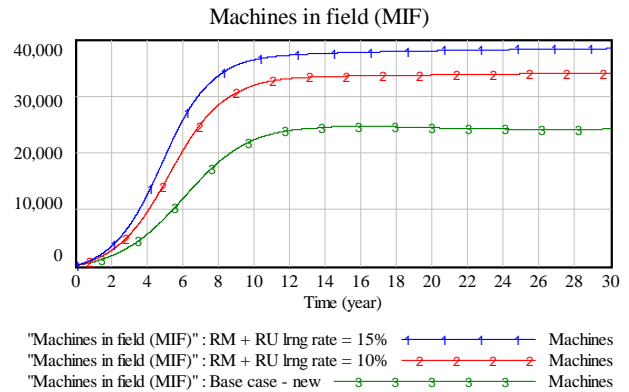
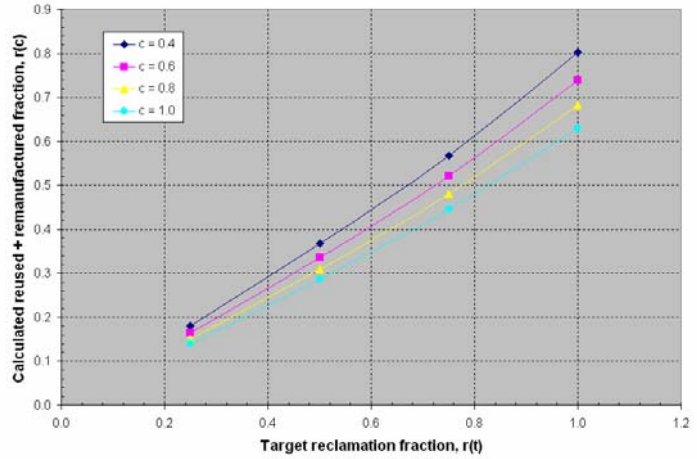

Fig. 14. Calculated equilibrium fractions of reclaimed material, r , in shipped products as a function of collection rate, c , and target levels.



The curves in Figure 14 suggest that the return fraction is acting as a brake on the return of reclaimed material to production. The apparent braking effect of increasing return fractions may be attributed to the relative cost structures of new and reclaimed parts. The different learning rates for new and reclaimed materials are the basis for this. The cost of each production machine (denoted by the subscript P) is a combination of the cost of the new components in it and the cost of the reclaimed materials in it. For each type of material, the cost is assumed to follow a generic power law learning curve:

$$C_i = C_0 V^b \quad (\text{Eqn. 1})$$

where C_i is the cost of the i -th machine, C_0 is the cost of the first machine, and b is the slope of the learning curve. Each material type then follows its own power law. For new (denoted by the subscript N) and reclaimed (denoted by the subscript R) materials, these are shown in Equations 2 and 3, respectively.

$$C_{N,j} = C_{N,0} V^d \quad (\text{Eqn. 2})$$

$$C_{R,k} = C_{R,0} V^e \quad (\text{Eqn. 3})$$

The n -th machine produced will have a cost, C_n , of

$$C_{P,n} = C_{N,j} + C_{R,k} \quad (\text{Eqn. 4})$$

The n -th machine represents the cumulative production of j equivalent new machines and k equivalent reclaimed machines:

$$n = j + k \quad (\text{Eqn. 5})$$

Combining equations (2) through (5), the effective learning curve slope, b , for the combination of new and reclaimed materials is:

$$b = \frac{\log \left[\frac{f^{d+1} C_{N,0} n^d + (1-f)^{e+1} C_{R,0} n^e}{f C_{N,0} + (1-f) C_{R,0}} \right]}{\log n} \quad (\text{Eqn. 6})$$

where f is the fraction of new materials in production unit n . Consequently, the effective learning rate for production machines is a non-linear function of the initial costs and the current fraction of new components used in production. The effect of the combination of the learning curves for new and reclaimed materials as defined in Table 1 is shown in Figure 15. Reclamation fractions were calculated from the simulation results. As the target reclamation rate increases, the more rapidly the effective learning rate decreases to that of the reclaimed material.

Fig. 15. Effective learning rate as a function of cumulative production and target reclamation fractions. The learning rates for new and reclaimed materials are as described in the text.

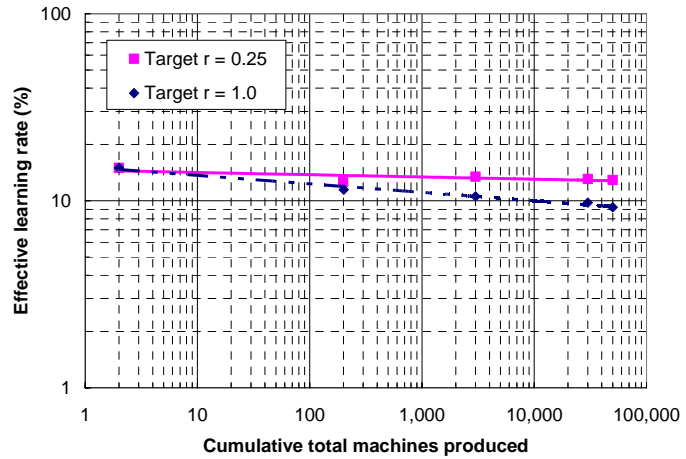

From Equation 6, it may be seen that, since a higher reclamation rate, (r_c), results in the use of higher fractions of components with a slower cost reduction rate, this will slow total cost reductions for the product. This is shown in Figure 16 for target reclamation fractions of 1.0 and 0.5. The effect on price translates to reduced sales (Figure 17) and fewer installed units (Figure 18). This is exactly the same effect observed in Figures 9 through 11 – increasing the learning rate of reclaimed materials toward that of new materials is the same as using fewer reclaimed materials with lower learning rates; the effective learning rate remains high, costs decrease more rapidly, and product sales and installations are greater.

The four sets of results shown in Figure 18 collapse to one curve, similar to that shown in Figure 17. This suggests that the reclamation fraction, r , is the real determinant of the system behavior. However, this may be an artifact of the assumption that the return fraction, c , is constant throughout the entire period modeled, while the reclamation fraction evolves over time.

Increased reclamation fractions lead to higher product prices and fewer sales. However, for the conditions considered in this work, they also lead to greater gross profits over the assumed 30-year product lifecycle (Figure 19). Consequently, achieving low disposal fractions may result in

a smaller market share due to fewer sales, but higher corporate profits.

The effect of the reclamation and return fractions on the disposal fraction of production machines is shown in Figure 20. The figure confirms that, although high reclamation fractions are achievable, they do not reach unity, so the disposal fraction may not reach zero.

Run	Equilibrium reclamation fraction, r	Collection fraction, c
1	0.630	1.00
3	0.287	1.00
9	0.739	0.60
11	0.336	0.60

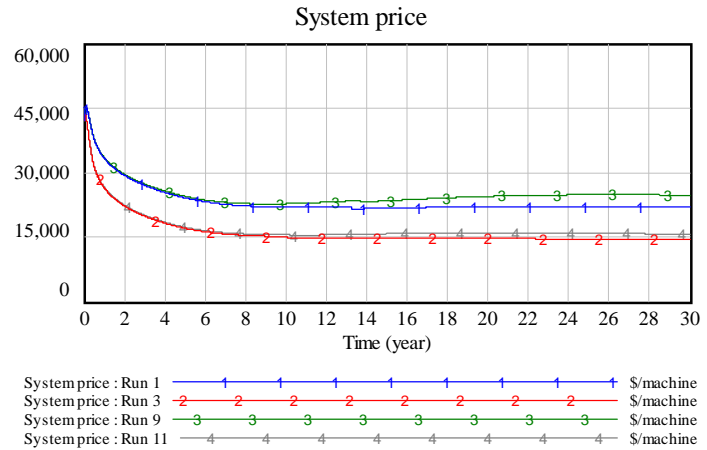
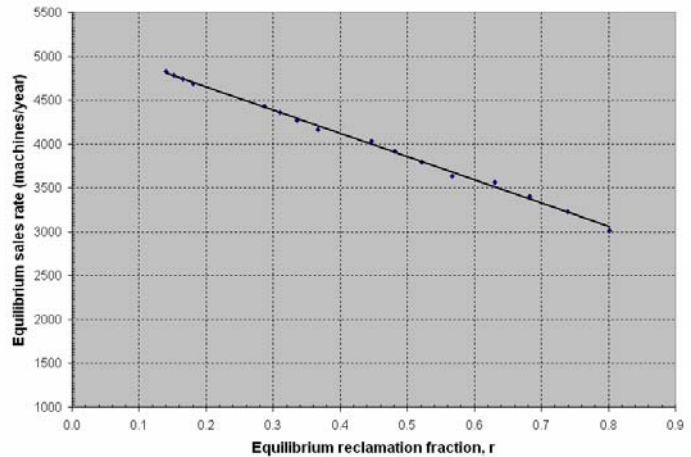

Fig. 16. Effect of reclamation fraction on product price. The target reclamation fraction for Runs 1 and 3 was 1.0, and was 0.5 for Runs 9 and 11.

Fig. 17. Effect of equilibrium reclamation fraction, r , on the equilibrium product sales rate.



Effective Component Lifetimes

Geyer, et al. (Geyer 2005), introduced the concept of an average number of lives, n , to denote the durability of reusable or remanufacturable components. This parameter is defined as the ratio of the average component life divided by the average life of the complete product. It is a measure of how many times components may be reused. The reclamation fraction, the collection rate, and the average number of lives were shown to be related by:

$$rc \leq (rc)_n \equiv \frac{c - c^n}{1 - c^n} \tag{Eqn. 7}$$

where $(rc)_n$ is the maximum achievable reclamation rate for a component with an average of n lives.

Fig. 18. Effect of equilibrium reclamation fraction, r , and product return rate, c , on the equilibrium installed fleet size, *Machines in field*.

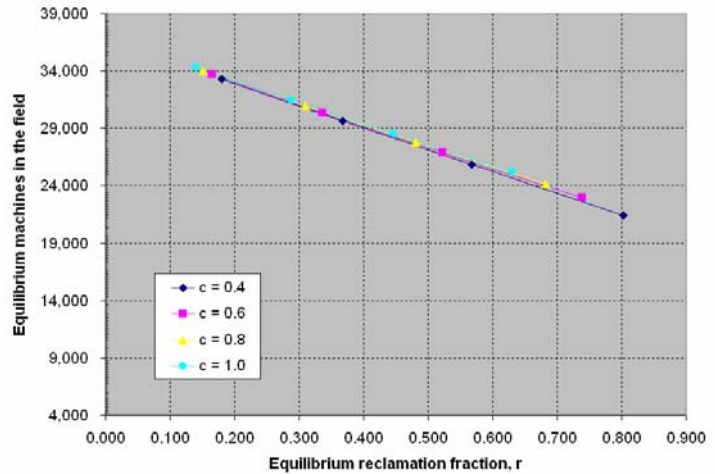

Fig. 19. Effect of equilibrium reclamation fraction, r , and product return fraction, c , on the cumulative gross profit of a product over an assumed 30-year lifecycle.

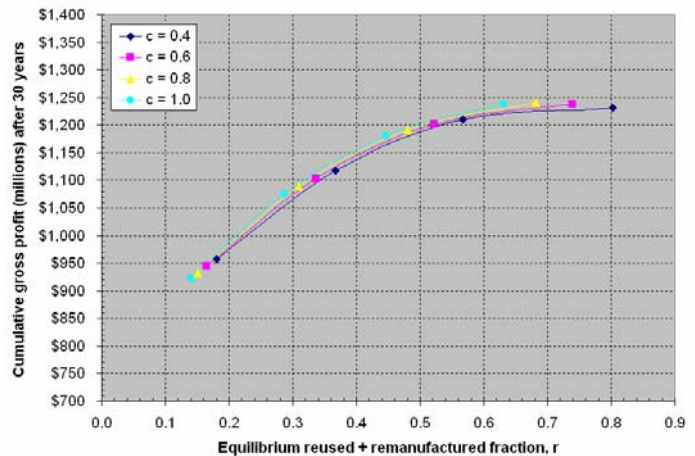
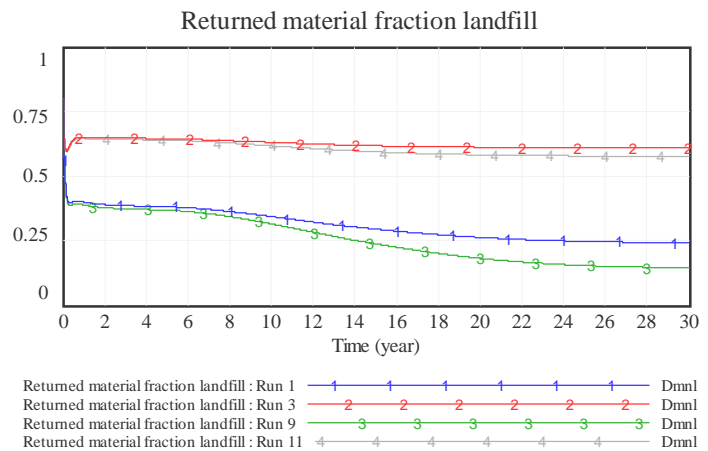

Fig. 20. Effect of equilibrium reclamation fraction, r , and product return fraction, c , on the cumulative gross profit of a product over an assumed 30-year lifecycle. See the table in Figure 16 for values of r and c for the runs shown.



If components have unlimited durability ($n \rightarrow \text{infinity}$), then $(rc)_n$ becomes equal to c . However, the more realistic expectation is that components have limited durability. The other limit, then, is the case of perfect collection ($c \rightarrow 1$), where $(rc)_n$ becomes

$$(rc)_n = \frac{n-1}{n} \quad (\text{Eqn. 8})$$

Table 2 shows the durability limit, that is, the average number of component lives, for different reclamation fractions in the case of perfect collection. Greater reclamation rates, (rc) , enable more component lives over the life cycle of a product. For the conditions and assumptions considered here, the average number of component lives is generally less than 2. For lower collection rates, the average number of component lives will be even less. Thus, to maximize reuse, the results confirm that a greater remanufacturing rate is required.

Table 2. Estimated average number of component lives for varying reclamation fractions, r, and with perfect collection of used components.		
Target r	Calculated r	Average number of component lives, n
1.00	0.627	2.68
0.75	0.444	1.80
0.50	0.286	1.40
0.25	0.139	1.16

Conclusions

Zero-to-landfill products are one means of meeting growing demands for extended producer responsibility. Such a strategy entails complex processes. A model, incorporating several improvements from an earlier one, was developed to study the dynamic effects of a 02L strategy. Several aspects of such a strategy were investigated.

Several significant conclusions may be drawn from the results of these simulations. First, achievement of a true 02L product, short of storing returned products in a warehouse, will be difficult. The amount of reclaimed material returned to production will determine the price of the outgoing products, ultimately impacting sales and, consequently, the number of returns for future reuse and remanufacturing. Further, the amount of reclaimed material used in production will drive corporate profits from such a product. For a representative scenario, increasing the amount of returned hardware will limit the amount of reclaimed material returned to production and the number of units sold, but will result in higher cumulative gross profits. Thus, companies considering development of zero-to-landfill products will have to balance market share, profits, and collection of products at the end of life. Restrictions in the system limit the ability to meet target reuse and remanufacturing content targets.

Proposed Future Work

The current model is sufficient to provide evaluation of the macroscopic parameters in a zero-to-landfill system. It is more representative of typical product life cycles than the previous one presented. However, not all of the potential improvements that identified in previous work have been made.

Additional detail is required in the cost models to better ascertain the economic viability of a 02L strategy and to identify more parameters that can be controlled on a local basis. Development of production cost estimates and process time estimates will improve the accuracy and the certainty of the results.

The model was extended to include corporate financial performance. However, there remains an implicit assumption that existing infrastructure is adequate to meet the demands of a product take-back system. Infrastructure costs may be added to reflect the potential need for increased facilities, vehicles, and so on. This work will further improve the ability of the simulations to project the impact on corporate finances.

An appropriate diffusion model has been included to generate more realistic adoption behavior. However, the model continues to lack the effect of customer perception of the quality of machines that do not consist of all new material. The effect of imperfect substitution will also be added. Some work on a modified Bass model to reflect substitution and endogenous limits on available material has already been reported (Debo 2005). In addition, exogenous behavior that influences the effective collection (return) rates may be included.

References

- Boyer JR, Elter JF. 2004. Using Simulations to Define the Product Development Strategy Expected to Achieve the Shortest Time to Profitability. *Proceedings of the 22nd International System Dynamics Conference*, Oxford, September 2004.
- Boyer JR, Elter JF. 2005. A model of the dynamic behavior of a zero-to-landfill strategy for consumer products. *Proceedings of the 23rd International System Dynamics Conference*, Boston, MA, September 2005.
- Brundtland Commission. 1987. *Our Common Future - Report of the World Commission on Environment and Development*. Oxford University Press: Oxford, England.
- Chen RW, Navin-Chandra D, Prinz FB. 1993. Product design for recyclability: A cost benefit analysis model and its application. *Proceedings of the 1993 IEEE International Symposium on Electronics and the Environment*, May 1993: 178 - 183.
- Debo LG, Toktay LB, Van Wassenhove LN. 2003. Market segmentation and product technology selection for remanufacturable products. *Working Paper*. INSEAD, Fontainebleu, France.
- Debo LG, Toktay LB, Van Wassenhove LN. 2005. Life cycle dynamics for portfolios with remanufactured products. *Working Paper*. INSEAD, Fontainebleu, France.
- de la Puente F, Flanigan L. 2005. Reverse logistics and remanufacturing. To be published.
- Dutton JM, Thomas A. 1984. Treating progress functions as a managerial opportunity. *Acad-*

- emy of Management Review*, [9]: 235-247.
- Geyer R., van Wassenhove, LN, Atasu A. 2005. The impact of limited component durability and finite life cycles on remanufacturing profit. INSEAD Working Paper. In press with *Management Science*.
- Hess R, Rushworth D, Hynes MV, Peters JE. 2001. *Disposal Options for Ships*. Rand Corporation: Santa Monica, California.
- Klausner M, Hendrickson CT. 2000. Reverse-logistics strategy for product take-back. *Interfaces*, [30]3: 156-165.
- Prahinski C, Kocabasoglu C. 2005. Empirical research opportunities in reverse supply chains. *International Journal of Management Science*, in press.
- Rogers DS, Tibben-Lembke RS. 1998. *Going Backwards: Reverse Logistics Trends and Practices*. Reverse Logistics Executive Council: Reno, Nevada.
- Sterman JD. 2000. *Business Dynamics: Systems Thinking and Modeling for a Complex World*. Irwin-McGraw Hill: Boston.
- Teplitz CJ. 1991. *The Learning Curve Deskbook*. Quorum Books: New York.
- Toffel MW. 2004. Strategic Management of Product Recovery. *California Management Review*, [46]2: 120-141.

Appendix

The complete model, with the exception of the cost and profit portions shown in Figures 5 and 6, respectively, of the text, is shown in the following figure.

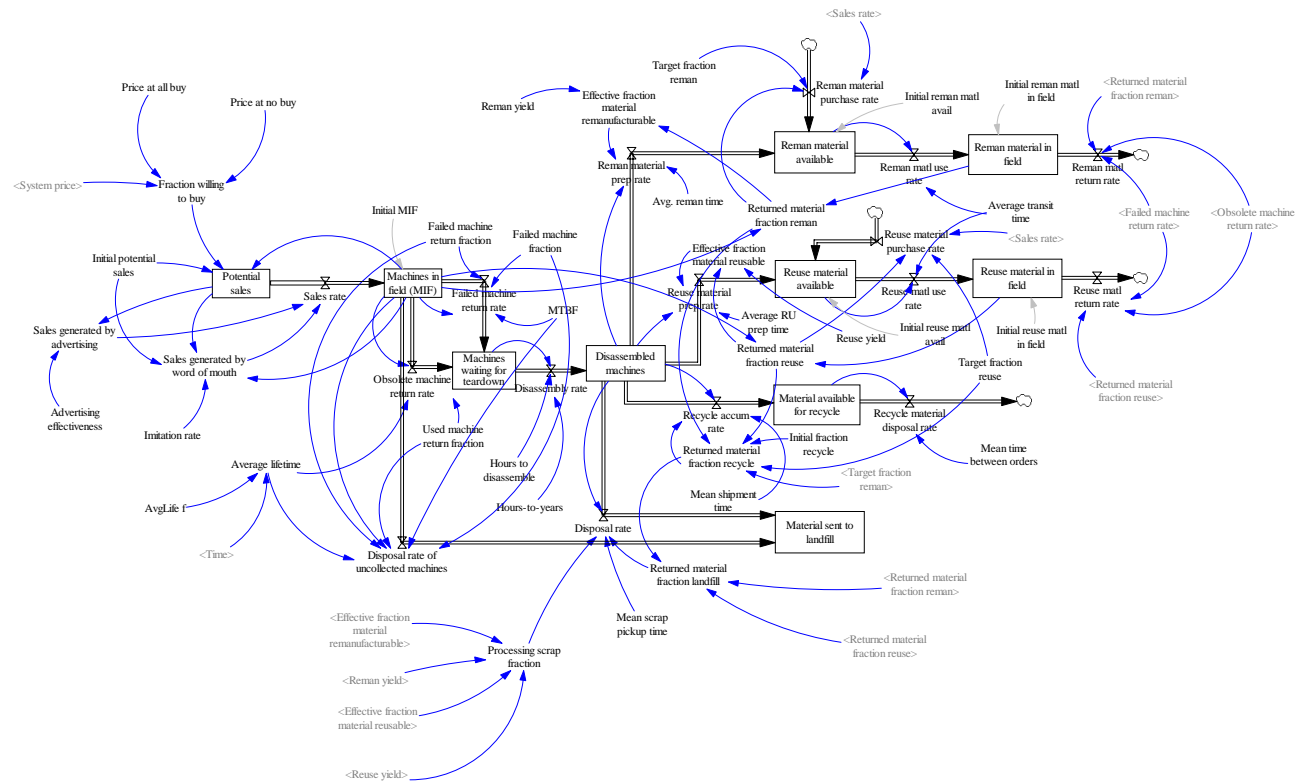

The Vensim program documentation follows.

- (001) Advertising effectiveness=
 $0.0006877 * 52$
 Units: 1/year
- (002) Average lifetime=
 $AvgLife f(Time)$
 Units: year
 Design product life.
- (003) Average number of component lives=
 $1/(1-(Effective\ fraction\ material\ remanufacturable + Effective\ fraction\ material\ reusable) * Failed\ machine\ return\ fraction))$
 Units: Dmnl
- (004) Average RU prep time=
 0.25
 Units: year
 Same as for reman.

- (005) Average transit time=
0.1
Units: year
Average time to move reman material from storage to production.
- (006) "Avg. reman time"=
0.25
Units: year
Average time for remanufacturing.
- (007) AvgLife f(
[(0,0)-(40,10)],(0,2),(5,10),(30,10))
Units: **undefined**
- (008) Cost to reman=
Reman cost for first machine*Cumulative reman matl^(ln(1-Reman cost learning rate)/ln(2))
Units: \$/machine
- (009) Cost to reuse=
Reuse cost for first machine*Cumulative reuse matl^(ln(1-Reuse cost learning rate)/ln(2))
Units: \$/machine
Same as for reman.
- (010) Cumulative machines= INTEG (
Sales rate,
Initial MIF)
Units: Machines
Total number of machines produced over time.
- (011) Cumulative new matl=
Cumulative machines-Cumulative reman matl-Cumulative reuse matl
Units: Machines
- (012) Cumulative reman matl= INTEG (
Reman matl use rate,
Initial reman matl avail+Initial reman matl in field)
Units: Machines
Total amount of reman material used.
- (013) Cumulative reuse matl= INTEG (
Reuse matl use rate,
Initial reuse matl avail+Initial reuse matl in field)
Units: Machines
Same as for reman.
- (014) Disassembled machines= INTEG (
Disassembly rate-Disposal rate-Recycle accum rate-Reman material prep rate
-Reuse material prep rate,
0)
Units: Machines
The amount of material, expressed as equivalent number of machines, ready for segregation, disposal, and processing.
- (015) Disassembly rate=

- Machines waiting for teardown/(Hours to disassemble/"Hours-to-years")
 Units: Machines/year
 Average time to disassemble a machine.
- (016) Disposal cost=
 75
 Units: \$/machine
- (017) Disposal rate=

$$\text{Disassembled machines} * (\text{Returned material fraction landfill} + \text{Processing scrap fraction}) / \text{Mean scrap pickup time}$$
 Units: Machines/year
 The average rate at which returned material is sent to landfill.
 Reflects non-usable and process waste material.
- (018) Disposal rate of uncollected machines=

$$((1 - \text{Failed machine return fraction}) * \text{Failed machine fraction} / \text{MTBF} + (1 - \text{Used machine return fraction}) / \text{Average lifetime}) * \text{Machines in field (MIF)}$$
 Units: Machines/year
- (019) Effective fraction material remanufacturable=

$$\text{Returned material fraction reman} * \text{Reman yield}$$
 Units: Dmnl
 The actual amount of returned material that will be available for another system.
- (020) Effective fraction material reusable=

$$\text{Reuse yield} * \text{Returned material fraction reuse}$$
 Units: Dmnl
 Same as for reman.
- (021) Equilibrium c=

$$\text{IF THEN ELSE}(\text{Returned material fraction reuse} > 0, (\text{Reuse matl use rate} / (\text{Failed machine return rate} + \text{Obsolete machine return rate})) / \text{Returned material fraction reuse} * \text{Failed machine return fraction}, 0)$$
 Units: Dmnl
- (022) Equilibrium rc=

$$\text{Equilibrium c} * r$$
 Units: **undefined**
- (023) Failed machine fraction=
 0.02
 Units: Dmnl
 The fraction of a machine that will be replaced - through preventive or corrective maintenance.
- (024) Failed machine return fraction=
 0.8
 Units: Dmnl
 Reflects an expectation that some failed or service parts will not be returned.
- (025) Failed machine return rate=

$$\text{"Machines in field (MIF)" * Failed machine fraction} * \text{Failed machine return fraction} / \text{MTBF}$$

- Units: Machines/year
The rate at which replaced components or machines are returned to the reverse logistics chain.
- (026) Final 1st unit cost=
Initial 1st unit cost*(Volume for LR change)^(ln(1-Initial NMLR)/ln(2) - ln(1-Final NMLR)/ln(2))
Units: \$/machine
- (027) Final NMLR=
0.05
Units: **undefined**
- (028) FINAL TIME = 30
Units: year
The final time for the simulation.
- (029) Fraction willing to buy=
IF THEN ELSE(System price>Price at no buy, 0, (1/(Price at all buy-Price at no buy))*System price+1))
Units: Dmnl
- (030) GM f(
[(0,0)-(60000,10)],(0,0.5),(25000,0.5),(50000,0))
Units: Dmnl
- (031) Gross margin=
GM f(System cost)
Units: Dmnl
\!System price\!
- (032) Hours to disassemble=
90
Units: Hours
Total time, on average, a machine is in the disassembly queue - includes actual disassembly and waiting time. Smooths the behavior, which in reality is probably more a step function.
- (033) "Hours-to-years"=
8760
Units: Hours/year
Convert hours to years.
- (034) Imitation rate=
0.01945 * 52
Units: 1/year
- (035) Initial 1st unit cost=
50000
Units: \$/machine
- (036) Initial fraction recycle=
0.2
Units: Dmnl
- (037) Initial MIF=

- 100
Units: Machines
The existing fleet of products at time = 0. Could be zero or could represent prototypes.
- (038) Initial NMLR=
0.15
Units: **undefined**
- (039) Initial potential sales=
50000
Units: Machines
- (040) Initial reman matl avail=
30
Units: Machines
Reflects initial use of reman material.
- (041) Initial reman matl in field=
0
Units: Machines
Reflects potential for existing machines to have reman material in them.
- (042) Initial reuse matl avail=
30
Units: Machines
Same as for reman.
- (043) Initial reuse matl in field=
0
Units: Machines
Same as for reman.
- (044) INITIAL TIME = 0
Units: year
The initial time for the simulation.
- (045) "Machines in field (MIF)"= INTEG (
Sales rate-Failed machine return rate-Obsolete machine return rate-Disposal rate of uncollected machines
,
Initial MIF)
Units: Machines
Installed base of product.
- (046) Machines waiting for teardown= INTEG (
+Failed machine return rate+Obsolete machine return rate-Disassembly rate
,
0)
Units: Machines
Machines entering the reverse logistics path, awaiting disassembly.
- (047) Material available for recycle= INTEG (
Recycle accum rate-Recycle material disposal rate,

- Units: Machines
Amount of recyclable material awaiting disposition / sales.
- (048) Material sent to landfill= INTEG (Disposal rate+Disposal rate of uncollected machines, 0)
Units: Machines
Total amount of material sent to landfill.
- (049) Mean scrap pickup time=
0.1
Units: year
- (050) Mean shipment time=
0.1
Units: year
Avg. time to move material from disassembly to collection point.
- (051) Mean time between orders=
0.25
Units: year
Average time between orders for recyclable material.
- (052) MTBF=
0.5
Units: year
Mean time between failures - an average for PM and CM.
- (053) New material cost first machine=
IF THEN ELSE(Cumulative machines<Volume for LR change, Initial 1st unit cost , Final 1st unit cost)
Units: \$/machine
Same as for reman.
- (054) New material cost learning rate=
IF THEN ELSE(Cumulative machines<Volume for LR change, Initial NMLR, Final NMLR)
Units: Dmnl
Same as for reman.
- (055) New matl cost contribution=
System cost all new*(1-Effective fraction material remanufacturable-Effective fraction material reusable)
Units: \$/machine
- (056) Obsolete machine return rate=
"Machines in field (MIF)"*Used machine return fraction/Average lifetime
Units: Machines/year
Rate at which machines reaching end of life are returned.
- (057) Potential sales=
max(0, Fraction willing to buy*Initial potential sales-"Machines in field (MIF)")
Units: Machines
- (058) Price at all buy=

- 0
Units: \$/machine
- (059) Price at no buy=
60000
Units: \$/machine
- (060) Processing scrap fraction=
Effective fraction material remanufacturable*(1-Reman yield)+Effective fraction material reusable
*(1-Reuse yield)
Units: Dmnl
The amount of returned material that becomes waste via reman and reuse processing.
- (061) Profit generation rate=
System price*Sales rate*Gross margin + Recycle material disposal rate*Revenue from recycled material
- Disposal cost*Disposal rate
Units: \$/year
- (062) r =
Effective fraction material remanufacturable+Effective fraction material reusable
Units: Dmnl
- (063) Recycle accum rate=
Disassembled machines*Returned material fraction recycle/Mean shipment time
Units: Machines/year
Average rate at which recyclable material is accumulated for future disposition.
- (064) Recycle material disposal rate=
Material available for recycle/Mean time between orders
Units: Machines/year
Average rate at which recyclable material is removed.
- (065) Reman cost contribution=
Effective fraction material remanufacturable*Cost to reman
Units: \$/machine
The cost for the fraction of a machine made from reman material.
- (066) Reman cost for first machine=
"RM-to-new cost ratio"*Initial 1st unit cost
Units: \$/machine
How much the first machine would cost if made from reman material.
- (067) Reman cost learning rate=
0.05
Units: Dmnl
The rate at which cost is reduced with each doubling of production.
- (068) Reman material available= INTEG (
Reman material prep rate+Reman material purchase rate-Reman matl use rate
,
Initial reman matl avail)
Units: Machines

Amount of remanufactured material awaiting use.

- (069) Reman material in field= INTEG (Reman matl use rate-Reman matl return rate, Initial reman matl in field)
Units: Machines
- (070) Reman material prep rate=
Disassembled machines*Effective fraction material remanufacturable/"Avg. reman time"
Units: Machines/year
Average rate of remanufacturing material.
- (071) Reman material purchase rate=
max(0,(Target fraction reman-Returned material fraction reman)*Sales rate)
Units: Machines/year
Average lead and delivery time for purchased material.
- (072) Reman matl return rate=
Returned material fraction reman*(Failed machine return rate+Obsolete machine return rate)
Units: Machines/year
Rate of return of remanufacturable material. Reflects average fraction of reman material in the field and the net return rate of material.
- (073) Reman matl use rate=
Reman material available/Average transit time
Units: Machines/year
Avg. rate of consumption of reman material.
- (074) Reman yield=
0.9
Units: Dmnl
Reflects losses in the reman processes.
- (075) Returned material fraction landfill=
1-Returned material fraction recycle-Returned material fraction reman-Returned material fraction reuse
Units: Dmnl
The amount of returned material that goes to landfill. Does not include processing waste.
- (076) Returned material fraction recycle=
IF THEN ELSE(Target fraction reman=0, Initial fraction recycle, max(0,Initial fraction recycle -Initial fraction recycle*(Returned material fraction reman+Returned material fraction reuse)/(Target fraction reuse+Target fraction reman)))
Units: Dmnl
Same as for reman. However, assumed that $f(RC) = f(RM, RU)$ and not a constant if there are RM and RU targets.
- (077) Returned material fraction reman=
Reman material in field/"Machines in field (MIF)"
Units: Dmnl
The average amount of returned material that is remanufacturable. Average of total reman in field and MIF.

- (078) Returned material fraction reuse=
 Reuse material in field/"Machines in field (MIF)"
 Units: Dmnl
 Same as for reman.
- (079) Reuse cost contribution=
 Effective fraction material reusable*Cost to reuse
 Units: \$/machine
 Same as for reman.
- (080) Reuse cost for first machine=
 "RU-to-new cost ratio"*Initial 1st unit cost
 Units: \$/machine
 Same as for reman.
- (081) Reuse cost learning rate=
 0.05
 Units: Dmnl
 Same as for reman.
- (082) Reuse material available= INTEG (
 Reuse material prep rate+Reuse material purchase rate-Reuse matl use rate
 ,
 Initial reuse matl avail)
 Units: Machines
 Same as for reman.
- (083) Reuse material in field= INTEG (
 Reuse matl use rate-Reuse matl return rate,
 Initial reuse matl in field)
 Units: Machines
 Same as for reman.
- (084) Reuse material prep rate=
 Disassembled machines*Effective fraction material reusable/Average RU prep time
 Units: Machines/year
 Same as for reman.
- (085) Reuse material purchase rate=
 max(0,(Target fraction reuse-Returned material fraction reuse)*Sales rate
)
 Units: Machines/year
 Same as for reman.
- (086) Reuse matl return rate=
 Returned material fraction reuse*(Failed machine return rate+Obsolete machine return rate
)
 Units: Machines/year
 Same as for reman.
- (087) Reuse matl use rate=
 Reuse material available/Average transit time
 Units: Machines/year
 Same as for reman.

- (088) Reuse yield=
0.9
Units: Dmnl
Same as for reman.
- (089) Revenue from recycled material=
500
Units: \$/machine
- (090) "RM-to-new cost ratio"=
0.66
Units: Dmnl
- (091) "RU-to-new cost ratio"=
0.66
Units: Dmnl
- (092) Sales generated by advertising=
Advertising effectiveness*Potential sales
Units: Machines/year
- (093) Sales generated by word of mouth=
Imitation rate*Potential sales*"Machines in field (MIF)"/Initial potential sales
Units: Machines/year
- (094) Sales rate=
Sales generated by advertising+Sales generated by word of mouth
Units: Machines/year
- (095) SAVEPER =
TIME STEP
Units: year [0,?]
The frequency with which output is stored.
- (096) System cost=
Reuse cost contribution+Reman cost contribution+New matl cost contribution
Units: \$/machine
Reflects all material costs - RM, RU, RC, LF.
- (097) System cost all new=
New material cost first machine*(Cumulative new matl)^(ln(1-New material cost learning rate)/ln(2))
Units: \$/machine
- (098) System cost savings=
System cost all new-System cost
Units: \$/machine
- (099) System price=
System cost/(1-Gross margin)
Units: \$/machine
Price to end customer.
- (100) Target fraction reman=
0.2
Units: Dmnl

A potential corporate goal. Influences purchases.

- (101) Target fraction reuse=
0.8
Units: Dmnl
Same as for reman.
- (102) TIME STEP = 0.0078125
Units: year [0,?]
The time step for the simulation.
- (103) Total gross profit= INTEG (
Profit generation rate,
0)
Units: \$
- (104) Used machine return fraction=
0.8
Units: Dmnl
Reflects an expectation that some product will not be returned
for a number of reasons.
- (105) Volume for LR change=
50000
Units: **undefined**