

## SYSTEM DYNAMICS MODELLING OF AN ACTIVATED SLUDGE PLANT

Bhakta Kabi Das<sup>1</sup>, Manas Bandyopadhyay<sup>1</sup>, and Pratap K. J. Mohapatra<sup>2</sup>

<sup>1</sup>Department of Civil Engineering

<sup>2</sup>Department of Industrial Engineering and Management

Indian Institute of Technology, Kharagpur

Kharagpur - 721 302, India

E.mail: pratap@hijli.iitkgp.ernet.in

### ABSTRACT

This paper systematically presents, with the help of flow diagrams, the development of a system dynamics model for an activated sludge plant which is used to treat the waste water biologically under aerobic conditions. Three different physical flows (hydraulic flow, biomass flow and flow of substrate) are considered in the model. The model is simulated with the help of IGRASP. The transient and steady-state behaviour of the growth of biomass, sludge production and the treatment efficiency, and their sensitivity to variations in physical (both environmental and physical) parameters are studied in detail. Strategies for recirculation of activated biomass in the treatment plant are evaluated. At the end, the paper indicates the merit of system dynamics modelling as a tool for conceptualising relationships, integrating knowledge about separate parts and evaluating control strategies in environmental systems.

### INTRODUCTION

The process of wastewater handling and its disposal has been a major concern for sustainable development in relation to human settlements and their allied industrial activities.

Activated sludge plants (ASP) are generally one type of sewage/effluent treatment plants, which employ the principles of biological processes, so as to convert soluble organic compounds into carbon dioxide, water, and micro-organism (i.e., bacteria cells). Since its inception circa 1914 by Adern and Lockett (Arceivala 1981), it has undergone a lot of systematic improvements, and today it is the most widely and popularly employed treatment technique for wastewater problems.

A number of research works (for example, Chiang 1977; Keinath et al. 1977; Sherrad 1977; and Eckenfelder 1986) have been devoted to the study of individual components of this treatment process. They have developed mathematical relationships among individual factors, estimated individual parameter values, and also tried to predict the performance of the system under varying systemic and environmental conditions. These studies are mostly fragmented and often one finds himself at a loss while conceptualizing the behaviour at an aggregate level.

A system dynamics model helps in putting together, at the aggregate level, the relationships and values that are known at the individual (or component) level. This power of synthesizing the component-level knowledge to estimate the behaviour at the aggregate level has been very useful in analyzing and recommending policy decisions in management and social systems (Mohapatra et al. 1994). Since the work on world dynamics by Forrester (1971), System Dynamics has been used in a number of environmental studies, prominent among them being those by Meadows and Meadows (1972), Freeman (1983) Vizayakumar (1990, 1991) and Vizayakumar and Mohapatra (1989, 1991).

In this paper, a system dynamics model has been developed for wastewater treatment by the activated sludge process. The relationships among the substrate, the biomass, the sludge, and its recirculation are modelled here. The model is tested for variations in the input rate, influent substrate concentration, and the volume of the aeration tank. The most viable recirculation policies have been examined.

### PRINCIPLES UNDERLYING THE WASTE TREATMENT THROUGH ASP

In general, as shown in Fig. 1, the influent stream which is rich in soluble organic compounds (known as Substrate or food for the bacteria), enters the reactor (known as Aeration tank AT). As the name depicts, the aeration or the supply of air and oxygen, is done by mechanical means so as to promote the bio-chemical activities of the bacteria within this tank. Here the bacteria culture consumes the substrate through the cell-wall diffusion mechanism (Grady and Lim 1980; Gaudy and Gaudy 1984) and grow in size and number on getting a conducive environment. Since bacteria are not so mobile in nature, the churning action of the mechanical aerators helps in bringing the substrate concentration close to the bacteria (or biomass (McKinney 1958). Thereafter, the sewage stream goes out of the aeration tank and reaches the clarifier. The clarifier allows some settling time and thus the biomass flocculate (or coalesce) to settle down as sludge. The sludge, so collected, contains the live (or active) biomass. It is recirculated to the aeration tank so as to maintain the biomass concentration or bacterial population at a desired level. The excess sludge which is not recirculated is withdrawn through the sludge drying beds and can be used as fertiliser. The clarified supernatant stream goes out of the system as treated effluent. Thus the system operates continuously and removes the soluble organic pollutants efficiently and economically.

To sum up, the essence of the principles underlying the activated sludge process is that the biomass, through its enzymatic actions, consumes the substrate and multiplies so as to form a flocculent, insoluble mass which separates from the system stream and settles down the clarifier.

Since this sort of sewage treatment system is continuously operated, the influent quantity and quality (in terms of pollutants) fluctuates diurnally (short range), seasonally (medium range), and with the variation in load (long-range). Thus, it is necessary to adjust the treatment system according to the type of the prevailing situation to achieve the desired effluent quantity. Thus in the process some time lag will occur.

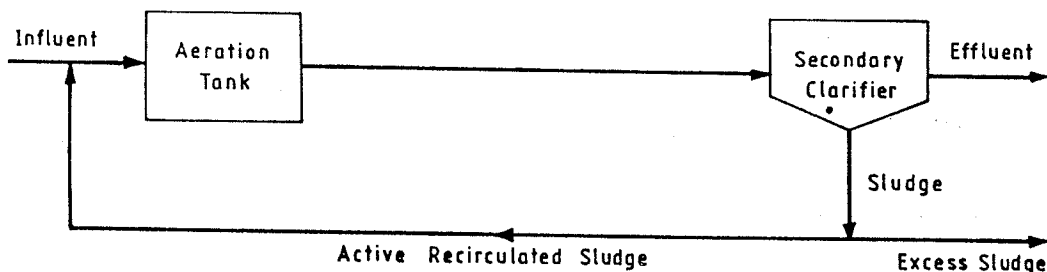

Figure 1. Physical Layout of an Activated Sludge Plant (ASP).

**SYSTEM DYNAMICS MODELLING OF WASTEWATER TREATMENT THROUGH ASP**

We can discern three main physical flows in ASP. These are the following:

- 1.Flow of hydraulic quantity (Fig. 2)
- 2.Flow of Biomass (Fig. 3), and
- 3.Flow of substrates/pollutants (Fig. 4).

Fig. 2 is flow diagram for the hydraulic flow in the ASP. It considers the volume of sewage in the aeration tank (VAT) and in the clarifier (UVC) as the levels, measured in  $M^3$  and the rate at which the inflow of sewage takes place into the AT (IRAT), the outflow from the AT (ORAT), the sludge volume withdrawal rate (SVWR), the sludge volume recirculation rate (SVRR), and the overflow rate from the clarifier(ORC), measured in  $M^3/hr$ .

The net inflow into the tank is the sum of the sewage inflow rate (IRAT) and the sludge recirculation rate (SVRR). It is assumed that the tank is full so that the outflow from the tank is always equal to the net inflow. Similarly, the net outflow form the clarifier is taken equal to

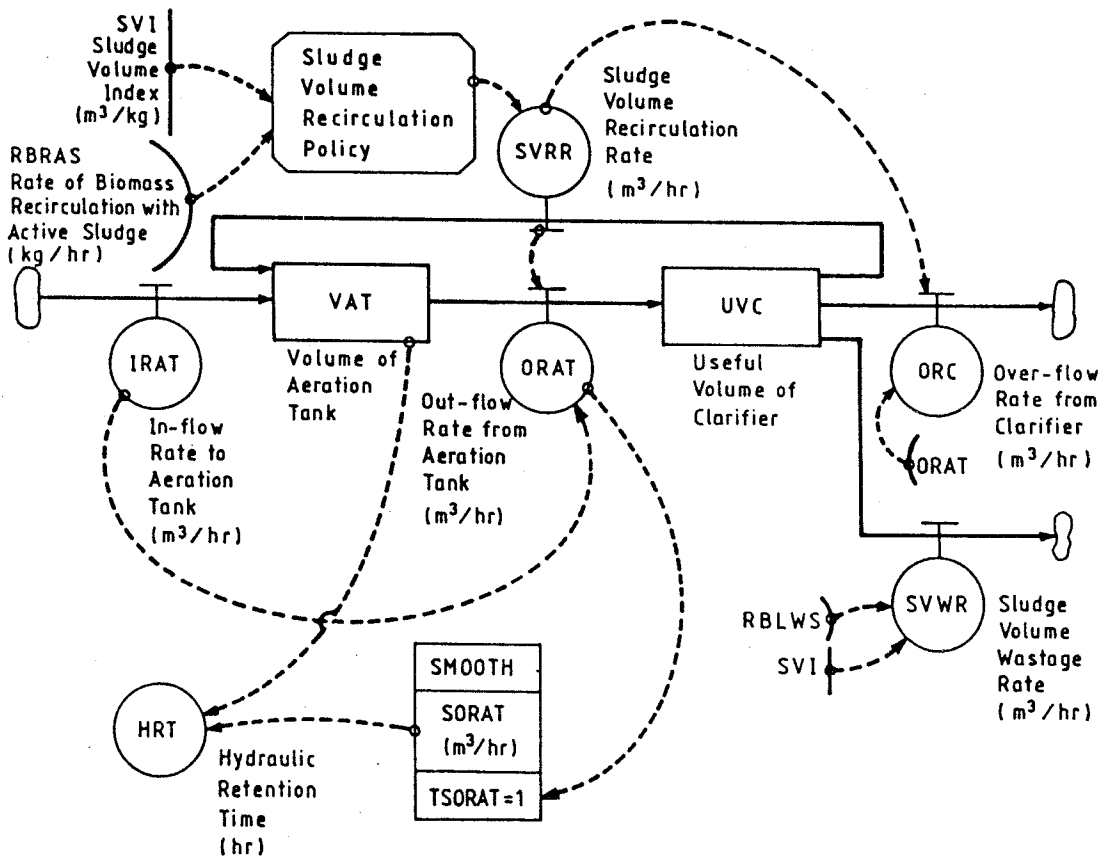

Figure 2. Flow Diagram for Sewage Quantity in the ASP System.



The SBGR (expressed in Kgs of biomass produced per Kgs of biomass per hour) is a function of the substrate concentration in the tank (SCAT) (discussed later) and the two other biomass culture specific coefficients i.e. the maximum value of SBGR and the saturation substrate concentration constant (SSCC). The above growth rate follows the well-known MONOD equation (Monod 1949). The biomass concentration in the tank (BCAT), considered as an auxiliary variable, is a ratio of BAT and VAT. For the Base run, it is considered that BDC represents the spontaneous death of viable biomass but not subjected to any stress (adverse temp, pH, substrate or nutrient conc.). However, subsequently, following Westberg (1967), BDC is assumed to depend on the substrate concentration. Since there is continuous stirring in the tank, the BCAT remains uniform throughout the tank. The rate of biomass leaving the tank (RBLAT) is a product of ORAT and BCAT.

Biomass settled in clarifier (BSC), considered as an auxiliary variable here, is a product of BTC and the percentage of settled biomass (PSB) (considered a constant). This factor is introduced here to compute the efficiency of the clarifier. Under the normal operating condition of the system, PSB is assumed as 90%; this implies that 90% of the biomass is retained in the clarifier as sludge. Sludge retention rate (SRR) is the ratio of BSC and the time of formation of sludge (TFS). The rate of biomass recirculated in the activated sludge (RBRAS) is a product of SRR and the recirculation ratio (RR). The biomass recirculation ratio is decided on the basis of the ratio of the actual food to microorganism ratio (AFMR) and the desired FMR. For average Indian conditions, DFMR is 0.2 (Arceivala, 1984). The remaining sludge (biomass) gets wasted from the system (RBLWS).

Fig.4 depicts the flow of the substrate in the system, in which the Substrate in the tank (SAT) is considered as a level. The rate of substrate inflow is the product of substrate

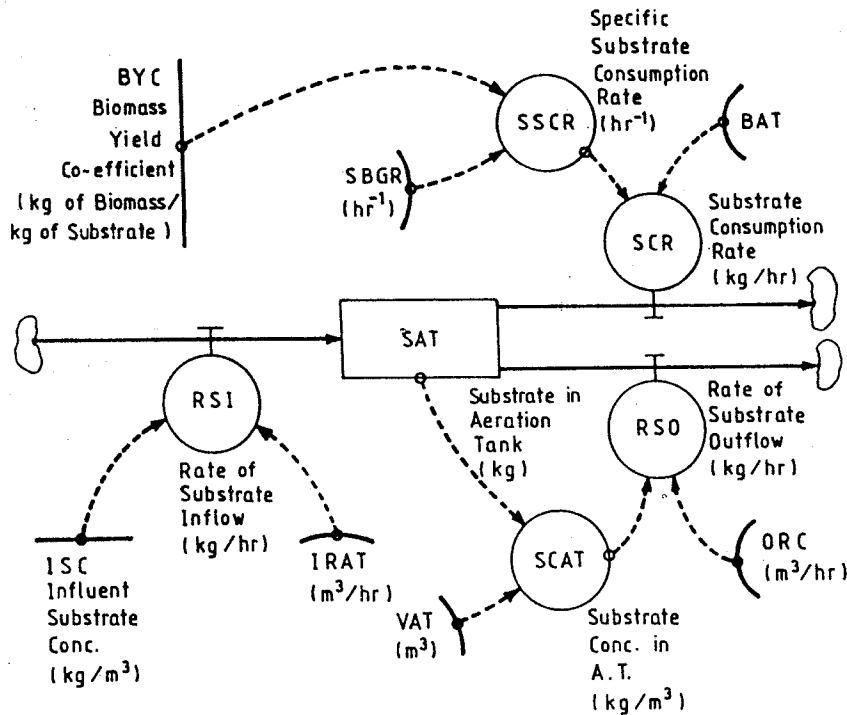

Figure 4 Flow Diagram for Substrate in the ASP System.

concentration (ISC) and IRAT. Due to biological actions, the consumption of substrate in the tank (SCR) occurs depending upon biomass (BAT), the specific (or unit) rate of substrate consumption (SSCR). SSCR, in turn, depends on the specific biomass growth rate (SBGR) and the biomass yield co-efficient (BYC), following the Monod's laws. The rate of substrate outflow (RSO) depends on SCAT and the overflow rate from the clarifier (ORC).

The model equations are written in IGRASP (Das et al. 1995) and then simulated for various conditions. The following conditions were assumed for the base simulation run.

1. The biomass culture is unique, viable and typically acclimatised with domestic sewage in aerobic environment.
  2. The pollution level is measured in terms of total carbon substrates and is expressed as BOD<sub>5</sub>.
  3. The Extended Aeration Method of ASP is considered for modelling here. (Hydraulic detention time is 16 Hrs.)
  4. Initial average influent rate (IRAT) is 200 M<sup>3</sup>/Hr for the base run.
  5. The volume of the aeration tank (VAT) is 3200 M<sup>3</sup> and is full with sewage in the initial stage.
  6. The initial Biomass concentration (IBC) is 0.01 Kg/M<sup>3</sup> and the initial influent substrate concentration (IBC) is 0.25 Kg/M<sup>3</sup>.
  - \*7. The typical Saturation substrate constant (SSCC) is 0.12 Kg/M<sup>3</sup>.
  - \*8. The typical maximum specific biomass growth rate (MSBGR) is 0.55 Kg/Kg/Hr.
  - \*9. The typical biomass decay coefficient (BDC) is 0.0025/Hr.
- (\*Mynhier and Grady, 1975)

## RESULTS AND DISCUSSION

Fig. 5 depicts a portion of the base run results simulated for 240 Hrs (10 days). Fig. 8 indicates that the biomass concentration is negligible during the first three hours, indicating the well-known lag phase of the bacterial growth. During this time, the substrate concentration rises. With ample substrate available, the biomass concentration rises in an exponential manner during the next two hours, indicating the well-known log phase, reaching a peak of about 2.5 Kg/M<sup>3</sup>. This rise in the biomass reduces the substrate concentration due to which the biomass concentration falls sharply during the next one hour, indicating the well-known endogenous phase. After a few cycles of diminishing fluctuations running up to twenty hours, the biomass and the substrate concentrations achieve the steady state.

The trends and fluctuations of biomass and substrate concentrations and the time to achieve stability match with the values that are generally experienced in practice. The viable biomass concentration in the tank more or less matches with other reported experimental results (such as those given by Weddle and Jenkins, 1971). The effluent substrate concentration stabilises within the reported range of 0.025 Kg/M<sup>3</sup> to 0.045 Kg/M<sup>3</sup>.

The sludge volume recirculation rate and the sludge volume withdrawal rate also behave in an expected fashion.

The model was tested for certain other conditions in order to examine the parameter sensitivity of the model and to determine the plant design and recycle strategies. These conditions are the following:

1. Varying inflow rate (Fig. 6)
2. Varying substrate concentrations (Fig. 7)

Parallel Program

- 3. Simultaneous variation of inflow rate and substrate concentration (Fig. 7)
- 4. Various reactor sizes (Fig. 8)

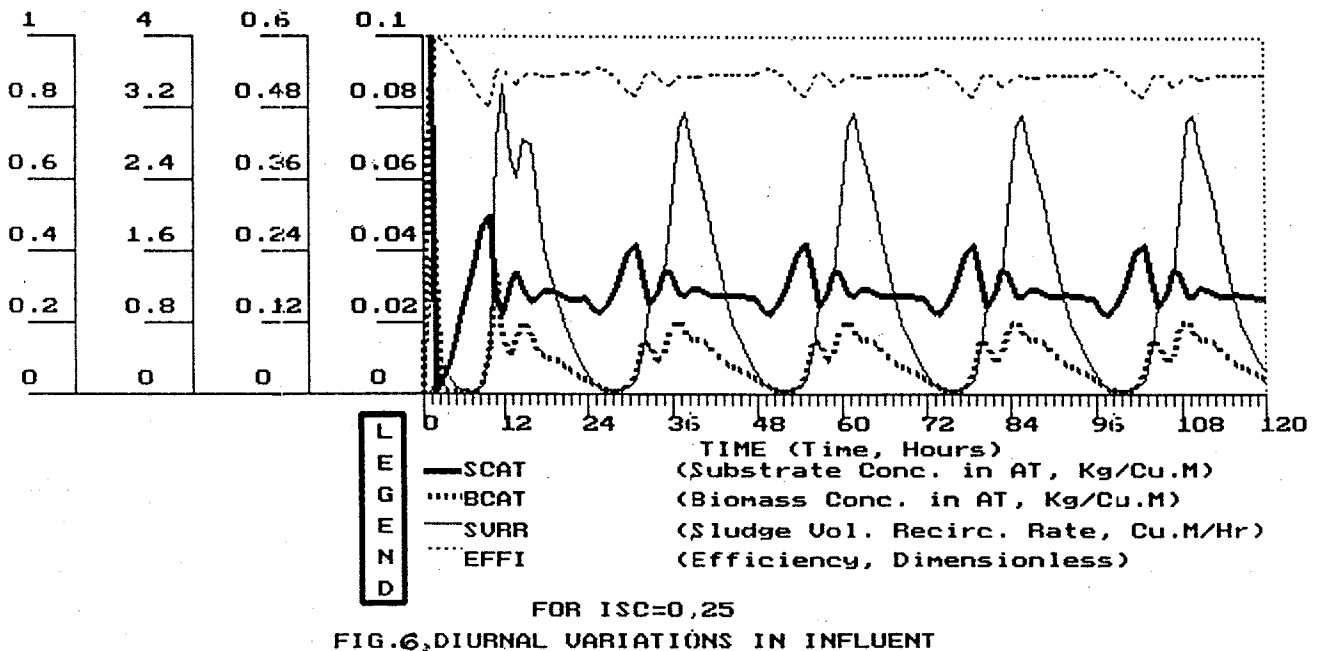
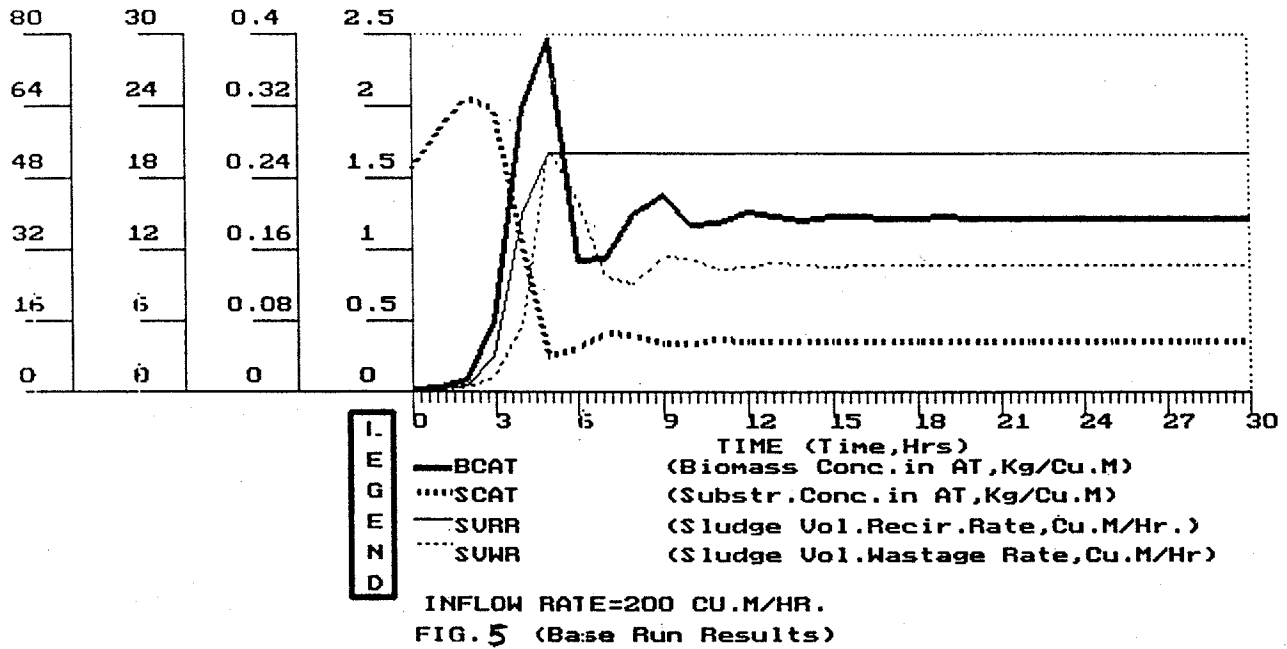

Fig.6 shows the effect of a typical diurnal variation of IRAT on BCAT, SCAT, SVRR and on efficiency in substrate removal. The sludge volume withdrawal rate is controlled to adjust itself to the desired recirculated sludge volume with a view to maintaining desired FMR in the tank and to achieve the effluent substrate concentration within reasonable limit. It is unnatural for an environmental engineer to see from the above referred figure that the biomass concentration becomes almost zero within a cycle. This happens, because, during about three hours in the midnight, the IRAT is considered to be zero and hence the biomass in the tank faces a substrate starvation condition, leading to an increase in the value of BDC (biomass death coeff).

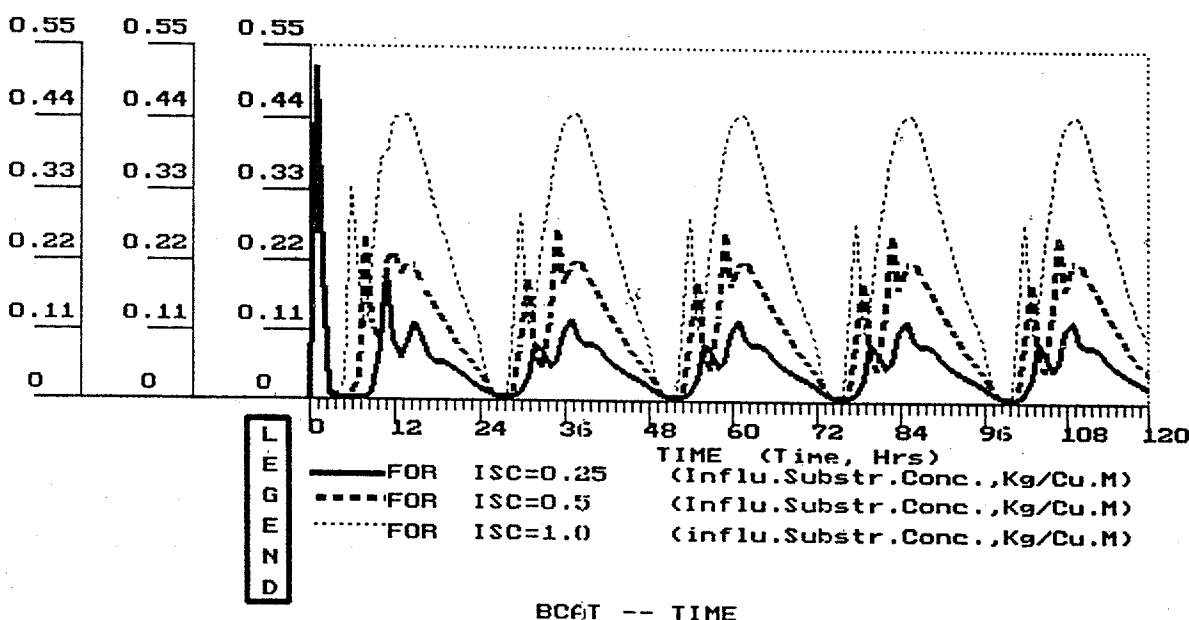

FIG.7. ( Variation of BIOMASS CONC.in AT with ISC)

Fig.7 shows the effect of variation of ISC on the viable biomass concentration in the tank. As the rate of substrate in the influent increases the fluctuations in BCAT increases and hence the sludge wastage rate increases.

Fig.8 shows the effect of variation of VAT on the efficiency. It is seen that as the VAT decreases the efficiency decreases in the peak periods. This is because, the hydraulic retention time decreases and hence the net biomass growth is hampered.

### CONCLUSIONS AND SCOPE OF FURTHER WORK

A number of research works have been done in the past on biomass growth, in particular reference to their use in wastewater treatment. Most of the results of these works, however, are fragmentary, and the underlying relationships among pertinent variables are not very evident. One therefore often finds it difficult to conceptualize the problem in an integrated manner and estimate the likely changes in the performance of the system due to variations of parameter and/or control policies.



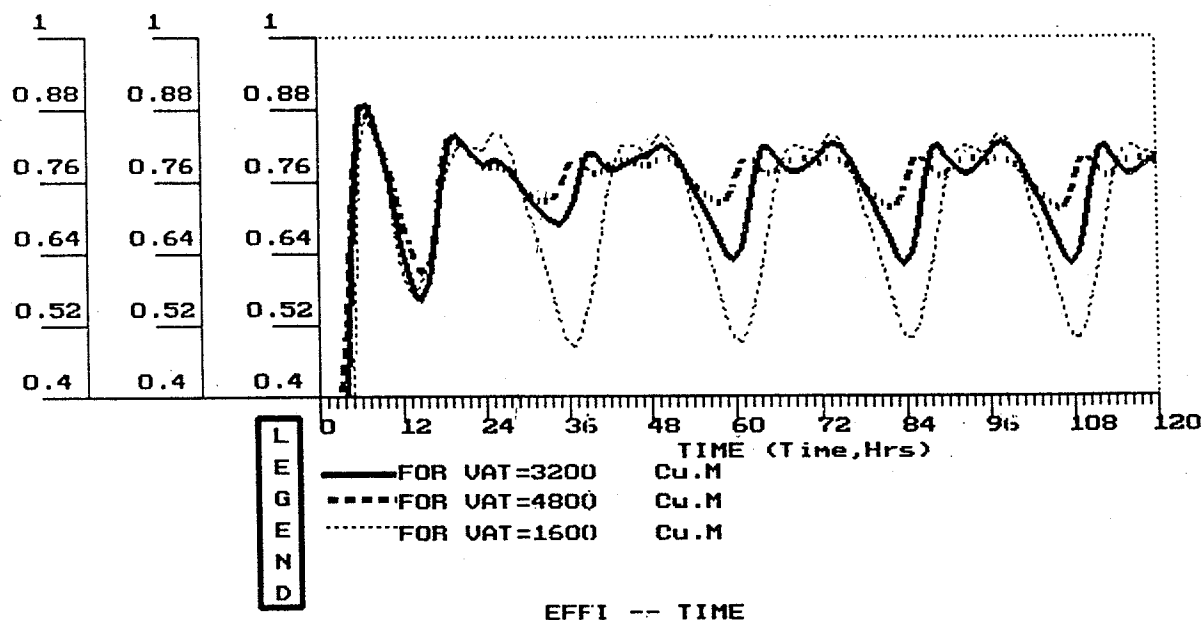

FIG.8 (Variation of EFFICIENCY with UOL of AT)

System dynamics modelling of the wastewater treatment by the process of activated sludge has helped in the following ways:

1. It has helped in forecasting the treatment efficiencies in varying conditions.
2. It has helped in conceptualizing, at an aggregate level, the individual cause and effect relationships and their effect on the performance of the treatment system under varying systemic and environmental conditions.
3. The model has helped in arriving at viable recirculation policies for various conditions.
4. The stock-flow relationships that were used to depict the treatment system has helped in understanding the mechanism of biomass growth, substrate depletion, sludge formation, and outflow quality in a very lucid way.

System Dynamics can prove to be an effective and useful tool for modeling of more complex environmental systems (for example, the Pollution treatment facilities) and can help in examining the sustainability of the environment due to any developmental activities.

The work reported here can be extended in the following directions:

1. Substrate as a level variable shall be further divided to consider Carbon, Phosphorous and Nitrogen as the other growth limiting substrates as individual levels.
2. The effect of other environmental parameters such as Oxygen content, pH and Temperature are to be integrated in the model.
3. The concept of Viable-Bacteria, Dead-Bacteria, Predators (Protozoa) and Fungi can be modelled so as to simulate the real situation.
4. The concept of single Completely Mixed Stirred Tank Reactor (CMSTR) and multi-CMSTR can also be integrated in the model.

## REFERENCES

- Arceivala, S. J. 1981. *Wastewater Treatment and Disposal: Engineering and Ecology in Pollution Control*. New York: Marcel Dekker, Inc.
- Chiang, H. C. 1977. Process Stability of ASP. *J. Environmental engineering Division*. American Society of Civil Engineers. 103(1): 259-272.

- Das, B., M. Juneja, S. Banerjee, I. Mukherjee, B. Mahanty, and P.K.J. Mohapatra. 1995. IGRASP: An Interactive Graphic Simulation Package, to be presented at the VI National Conference on System Dynamics at Nagpur.
- Eckenfelder, W. W., D. L. Ford, P. W. Lankford, G. Shell, & D. L. Sullivan. 1986. *Operation, Control & Management of Activated Sludge Plants treating Industrial Wastewater*, Tennessee: Vanderbilt University.
- Forrester, J. W. 1971. *World Dynamics*. Cambridge: The Productivity Press.
- Freeman, T. G. and P. R. Benyan (eds.). 1983. *Pastoral and Social Problems in a Semi-arid Environment: A simulation Model*. Canberra: CSIRP.
- Gaudy, A. F. and Gaudy, E. T. 1984. *Environmental Microbiology*. New York: Mc-Graw Hill, Inc.
- Grady, C. P. L. Jr. and H. C. Lim. 1980. *Biological Wastewater Treatment: Theory and Applications*. New York: Marcel Dekker, Inc.
- Keinath T. M., M. D. Ryekman and C. H. Dana. 1977. Activated Sludge - Unified System Design & Operation. *J. Environmental engineering Division, American Society of Civil Engineers*. 103( 5): 829-849.
- Meadows, D.L. and D. H. Meadows (Eds). 1973. *Toward Global Equilibrium: Collected Papers*. Mass: Wright-Allen Press, Inc.
- Mohapatra, P. K. J., P. Mandal, and M. C. Bora. 1994. *Introduction to System Dynamics Modeling*. Hyderabad, India: Orient Longman Ltd.
- Monod, J. 1949. The Growth of Bacterial Cultures. *Annual Review of Microbiology*. 1(3): 371-394.
- Mynhier, M. D. and C. P. L. Grady. 1975. Design Graphs for Activated Sludge Process. *J. Environmental Engineering Division, American Society of Civil Engineers*. 101(4 ): 829-846.
- Sherrard, J. H. 1977. Kinetics & Stoichiometry of Completely Mixed Activated Sludge. *J. Water Pollution Control Federation*. 49:1968-1975.
- Vizayakumar, K. 1990. *A study on Some Aspects of Environmental Impact Analysis* Ph.D Thesis. IIT, Kharagpur.
- Vizayakumar, K. 1991. An Interactive System Dynamics Based Game for Environmental Policy Making. *System Dynamics: An Int. J. of Policy Modelling*. 4 (1&2): 73-93.
- Vizayakumar, K. and P. K. J. Mohapatra. 1989. A Dynamic Simulation Approach to Environmental Impact Analysis. *System Dynamics: An Int. J. of Policy Modelling*. 2 (2):45-61.
- Vizayakumar, K. and P. K. J. Mohapatra. 1991. Environmental Impact Analysis of a Coalfield *J. of Environmental Management* 34:73-93.
- Weddle, C. L. & D. Jenkins. 1971. The Viability and Activity of Activated Sludge. *Water Research*. 5:621-640.
- Westberg, N.(1967), A Study of Activated Sludge Process as a Bacterial Growth Process, *Water Research*. 1: 795-804.